

BIPOLAR ANALOG INTEGRATED CIRCUIT

μ PC29xxB Series

THREE-TERMINAL LOW DROPOUT VOLTAGE REGULATOR (OUTPUT CURRENT: 1.0 A)

DESCRIPTION

The μ PC29xxB series is a series of three-terminal low dropout voltage regulators with 1.0 A output current. This series is suitable for low voltage operated IC and has 4 output voltage types, 1.8 V, 2.5 V, 3.3 V and 5.0 V. Compared with the μ PC29xx and μ PC29xxA series, this series has improved output voltage tolerance ($V_o \pm 2\%$), quiescent current (1.8 mA TYP. ($I_o = 0$ A)), and short-circuit current.

FEATURES

- Output current capacity: 1.0 A
- Output voltage tolerance: $V_o \pm 2\%$ ($T_A = 25^\circ\text{C}$)
- Low quiescent current: 1.8 mA TYP. ($I_o = 0$ A)
- Low short-circuit current: 0.3 A TYP. (μ PC2918B), 0.6 A TYP. (μ PC2925B, μ PC2933B), 0.65 A TYP. (μ PC2905B)
- Low dropout voltage: $V_{DIF} = 0.6$ V MAX. ($I_o = 0.5$ A)
- On-chip inrush current protection circuit at the time of input voltage rising (when input voltage is low)
- On-chip over-current limiter
- On-chip thermal shut down circuit

APPLICATIONS

Digital TV, DVD, LCD Monitors, Printers, Audio, Air Conditioners, and other applications.

PIN CONFIGURATIONS (Marking Side)

Isolated TO-220 (MP-45G)

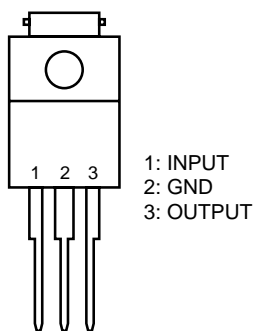

SC-64 (MP-3)

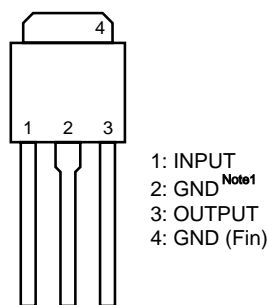

SC-63 (MP-3Z)

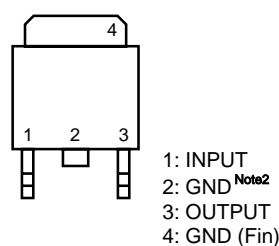

TO-252 (MP-3ZK)

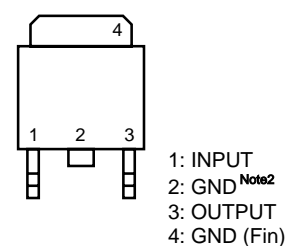

Notes 1. No.2 pin and No.4 fin are common GND.

2. No.2 pin is cut. No.2 pin and No.4 fin are common GND.

The information in this document is subject to change without notice. Before using this document, please confirm that this is the latest version.
Not all products and/or types are available in every country. Please check with an NEC Electronics sales representative for availability and additional information.

BLOCK DIAGRAM

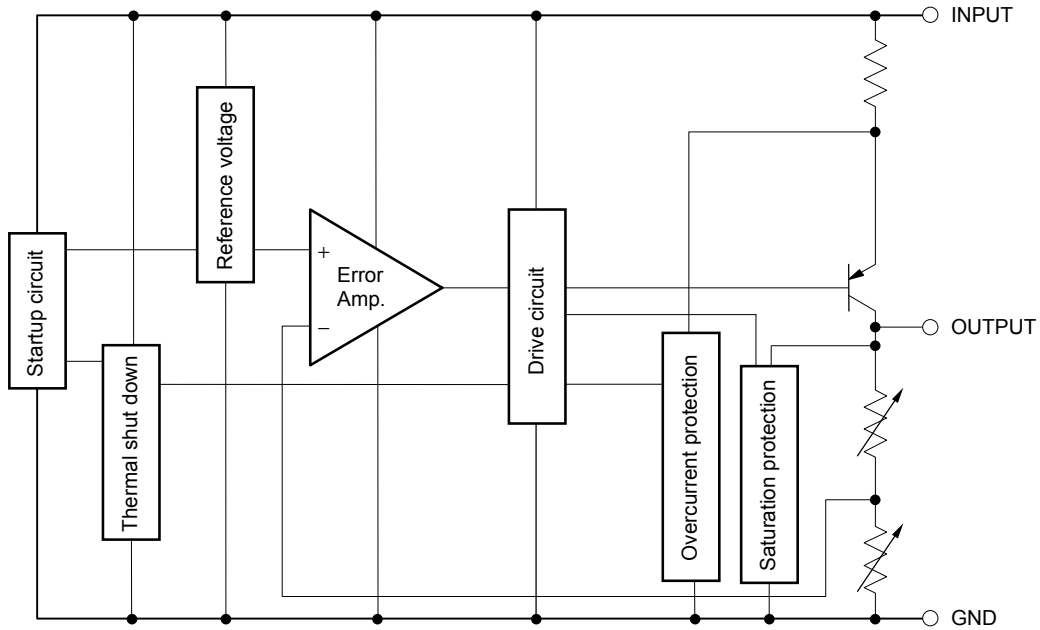

<R> **ORDERING INFORMATION**

Part Number	Package	Output Voltage	Marking
μPC2918BHF	Isolated TO-220 (MP-45G)	1.8 V	2918B
μPC2918BHB	SC-64 (MP-3)	1.8 V	2918B
μPC2918BT	SC-63 (MP-3Z)	1.8 V	2918B
μPC2918BT1D	TO-252 (MP-3ZK)	1.8 V	2918BD
μPC2925BHF	Isolated TO-220 (MP-45G)	2.5 V	2925B
μPC2925BHB	SC-64 (MP-3)	2.5 V	2925B
μPC2925BT	SC-63 (MP-3Z)	2.5 V	2925B
μPC2925BT1D	TO-252 (MP-3ZK)	2.5 V	2925BD
μPC2933BHF	Isolated TO-220 (MP-45G)	3.3 V	2933B
μPC2933BHB	SC-64 (MP-3)	3.3 V	2933B
μPC2933BT	SC-63 (MP-3Z)	3.3 V	2933B
μPC2933BT1D	TO-252 (MP-3ZK)	3.3 V	2933BD
μPC2905BHF	Isolated TO-220 (MP-45G)	5.0 V	2905B
μPC2905BHB	SC-64 (MP-3)	5.0 V	2905B
μPC2905BT	SC-63 (MP-3Z)	5.0 V	2905B
μPC2905BT1D	TO-252 (MP-3ZK)	5.0 V	2905BD

Remark Tape-packaged products have the symbol -E1, or -E2 suffixed to the part number. In Pb-free products, any of -AT, -AZ or -AY is added to the end of their part number. Refer to the following table for details.

Part Number ^{Note1}	Package	Package Type
μPC29xxBHF	Isolated TO-220 (MP-45G)	• Packed in envelop
μPC29xxBHF-AZ ^{Note2}	Isolated TO-220 (MP-45G)	• Packed in envelop
μPC29xxBHB	SC-64 (MP-3)	• Packed in envelop
μPC29xxBHB-AZ ^{Note2}	SC-64 (MP-3)	• Packed in envelop
μPC29xxBHB-AY ^{Note3}	SC-64 (MP-3)	• Packed in envelop
μPC29xxBT	SC-63 (MP-3Z)	• Packed in envelop
μPC29xxBT-AZ ^{Note2}	SC-63 (MP-3Z)	• Packed in envelop
μPC29xxBT-E1	SC-63 (MP-3Z)	• 16 mm wide embossed taping • Pin 1 on draw-out side • 2000 pcs/reel
μPC29xxBT-E1-AZ ^{Note2}	SC-63 (MP-3Z)	• 16 mm wide embossed taping • Pin 1 on draw-out side • 2000 pcs/reel
μPC29xxBT-E1-AY ^{Note3}	SC-63 (MP-3Z)	• 16 mm wide embossed taping • Pin 1 on draw-out side • 2000 pcs/reel
μPC29xxBT-E2	SC-63 (MP-3Z)	• 16 mm wide embossed taping • Pin 1 at take-up side • 2000 pcs/reel
μPC29xxBT-E2-AZ ^{Note2}	SC-63 (MP-3Z)	• 16 mm wide embossed taping • Pin 1 at take-up side • 2000 pcs/reel
μPC29xxBT-E2-AY ^{Note3}	SC-63 (MP-3Z)	• 16 mm wide embossed taping • Pin 1 at take-up side • 2000 pcs/reel
μPC29xxBT1D-E1	TO-252 (MP-3ZK)	• 16 mm wide embossed taping • Pin 1 on draw-out side • 2500 pcs/reel
μPC29xxBT1D-E1-AT ^{Note4}	TO-252 (MP-3ZK)	• 16 mm wide embossed taping • Pin 1 on draw-out side • 2500 pcs/reel
μPC29xxBT1D-E2	TO-252 (MP-3ZK)	• 16 mm wide embossed taping • Pin 1 at take-up side • 2500 pcs/reel
μPC29xxBT1D-E2-AT ^{Note4}	TO-252 (MP-3ZK)	• 16 mm wide embossed taping • Pin 1 at take-up side • 2500 pcs/reel

Notes 1. xx stands for symbols that indicate the output voltage.

2. Pb-free (This product does not contain Pb in the external electrode.)
3. Pb-free (This product does not contain Pb in the external electrode, Sn100% plating.)
4. Pb-free (This product does not contain Pb in the external electrode and other parts.)

ABSOLUTE MAXIMUM RATINGS (T_A = 25°C, unless otherwise specified)

Parameter	Symbol	Rating		Unit
		μPC29xxBHF	μPC29xxBHB, μPC29xxBT, μPC29xxBT1D	
Input Voltage	V _{IN}	-0.3 to +16.0		V
Internal Power Dissipation (T _C = 25°C) ^{Note}	P _T	15	10	W
Operating Ambient Temperature	T _A	-40 to +85		°C
Operating Junction Temperature	T _J	-40 to +150		°C
Storage Temperature	T _{stg}	-55 to +150		°C
Thermal Resistance (junction to case)	R _{th(J-C)}	7	12.5	°C/W
Thermal Resistance (junction to ambient)	R _{th(J-A)}	65	125	°C/W

Note Internally limited. When the operating junction temperature rises above 150°C, the internal circuit shuts down the output voltage.

Caution Product quality may suffer if the absolute maximum rating is exceeded even momentarily for any parameter. That is, the absolute maximum ratings are rated values at which the product is on the verge of suffering physical damage, and therefore the product must be used under conditions that ensure that the absolute maximum ratings are not exceeded.

TYPICAL CONNECTION

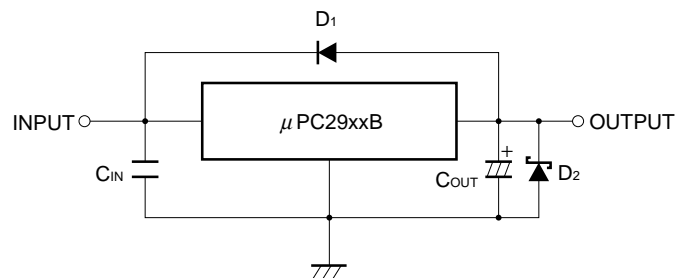

C_{IN} : 0.1 μF or higher. Be sure to connect C_{IN} to prevent parasitic oscillation. Set this value according to the length of the line between the regulator and the INPUT pin. Use of a film capacitor or other capacitor with first-rate voltage and temperature characteristics is recommended. If using a laminated ceramic capacitor, it is necessary to ensure that C_{IN} is 0.1 μF or higher for the voltage and temperature range to be used.

C_{OUT}: 10 μF or higher. Be sure to connect C_{OUT} to prevent oscillation and improve excessive load regulation. Place C_{IN} and C_{OUT} as close as possible to the IC pins (within 1 to 2 cm). Also, use an electrolytic capacitor with low impedance characteristics if considering use at sub-zero temperatures.

D₁ : If the OUTPUT pin has a higher voltage than the INPUT pin, connect a diode.

D₂ : If the OUTPUT pin has a lower voltage than the GND pin, connect a Schottky barrier diode.

Caution Make sure that no voltage is applied to the OUTPUT pin from external.

RECOMMENDED OPERATING CONDITIONS

Parameter	Symbol	Type Number	MIN.	TYP.	MAX.	Unit
Input Voltage	V _{IN}	μPC2918B	2.8		12.0	V
		μPC2925B	3.5		12.0	V
		μPC2933B	4.3		12.0	V
		μPC2905B	6.0		12.0	V
Output Current	I _o	All	0		1.0	A
Operating Ambient Temperature	T _A	All	-40		+85	°C
Operating Junction Temperature	T _J	All	-40		+125	°C

Caution Use of conditions exceeding the above-listed recommended operating conditions is not a problem as long as the absolute maximum ratings are not exceeded. However, since the use of such conditions diminishes the margin of safety, careful evaluation is required before such conditions are used.

ELECTRICAL CHARACTERISTICS

μPC2918B (T_J = 25°C, V_{IN} = 2.8 V, I_o = 0.5 A, C_{IN} = 0.1 μF, C_{OUT} = 10 μF, unless otherwise specified)

Parameter	Symbol	Conditions	MIN.	TYP.	MAX.	Unit
Output Voltage	V _{O1}		1.764	1.8	1.836	V
	V _{O2}	2.8 V ≤ V _{IN} ≤ 12 V, 0 A ≤ I _o ≤ 1 A	(1.746)	–	(1.854)	V
Line Regulation	REG _{IN}	2.8 V ≤ V _{IN} ≤ 12 V	–	4.0	25.0	mV
Load Regulation	REG _L	0 A ≤ I _o ≤ 1 A	–	3.5	30.0	mV
Quiescent Current	I _{BIAS}	I _o = 0 A	–	1.8	4.0	mA
		I _o = 0.5 A	–	18.0	(30.0)	mA
Startup Quiescent Current	I _{BIAS(S)}	V _{IN} = 1.7 V, I _o = 0 A	–	1.0	30.0	mA
		V _{IN} = 2.4 V, I _o = 1 A	–	–	(80.0)	mA
Quiescent Current Change	ΔI _{BIAS}	2.8 V ≤ V _{IN} ≤ 12 V	–	(3.0)	(15.0)	mA
Output Noise Voltage	V _n	10 Hz ≤ f ≤ 100 kHz	–	50.0	–	μV _{r.m.s.}
Ripple Rejection	R•R	f = 120 Hz, 2.8 V ≤ V _{IN} ≤ 3.8 V, I _o = 0.3 A	–	62	–	dB
Dropout Voltage	V _{DIF}	I _o = 0.5 A	–	0.3	0.6	V
		I _o = 1 A	–	(0.7)	–	V
Short Circuit Current	I _{Oshort}	V _{IN} = 2.8 V	(0.1)	0.3	(0.8)	A
		V _{IN} = 12 V	–	(0.4)	–	A
Peak Output Current	I _{Opeak}	V _{IN} = 2.8 V	1.0	1.3	(1.6)	A
		V _{IN} = 12 V	–	(1.1)	–	A
Temperature Coefficient of Output Voltage	ΔV _O /ΔT	0°C ≤ T _J ≤ 125°C, I _o = 5 mA	–	0.1	–	mV/°C

Remark Values in parentheses are product design values, and are thus provided as reference values.

μPC2925B (T_J = 25°C, V_{IN} = 3.5 V, I_O = 0.5 A, C_{IN} = 0.1 μF, C_{OUT} = 10 μF, unless otherwise specified)

Parameter	Symbol	Conditions	MIN.	TYP.	MAX.	Unit
Output Voltage	V _{O1}		2.45	2.5	2.55	V
	V _{O2}	3.5 V ≤ V _{IN} ≤ 12 V, 0 A ≤ I _O ≤ 1 A	(2.425)	–	(2.575)	V
Line Regulation	REG _{IN}	3.5 V ≤ V _{IN} ≤ 12 V	–	5.5	25.0	mV
Load Regulation	REG _L	0 A ≤ I _O ≤ 1 A	–	3.5	40.0	mV
Quiescent Current	I _{BIAS}	I _O = 0 A	–	1.8	4.0	mA
		I _O = 0.5 A	–	18.0	(30.0)	mA
Startup Quiescent Current	I _{BIAS(S)}	V _{IN} = 2.4 V, I _O = 0 A	–	11.0	30.0	mA
		V _{IN} = 3.1 V, I _O = 1 A	–	–	(80.0)	mA
Quiescent Current Change	ΔI _{BIAS}	3.5 V ≤ V _{IN} ≤ 12 V	–	(3.0)	(15.0)	mA
Output Noise Voltage	V _n	10 Hz ≤ f ≤ 100 kHz	–	62.0	–	μV _{r.m.s.}
Ripple Rejection	R•R	f = 120 Hz, 3.5 V ≤ V _{IN} ≤ 4.5 V, I _O = 0.3 A	–	60	–	dB
Dropout Voltage	V _{DIF}	I _O = 0.5 A	–	0.36	0.6	V
		I _O = 1 A	–	(0.7)	–	V
Short Circuit Current	I _{Oshort}	V _{IN} = 3.5 V	(0.1)	0.6	(0.8)	A
		V _{IN} = 12 V	–	(0.4)	–	A
Peak Output Current	I _{Opeak}	V _{IN} = 3.5 V	1.0	1.3	(1.6)	A
		V _{IN} = 12 V	–	(1.1)	–	A
Temperature Coefficient of Output Voltage	ΔV _O /ΔT	0°C ≤ T _J ≤ 125°C, I _O = 5 mA	–	0.2	–	mV/°C

Remark Values in parentheses are product design values, and are thus provided as reference values.

μPC2933B (T_J = 25°C, V_{IN} = 5.0 V, I_O = 0.5 A, C_{IN} = 0.1 μF, C_{OUT} = 10 μF, unless otherwise specified)

Parameter	Symbol	Conditions	MIN.	TYP.	MAX.	Unit
Output Voltage	V _{O1}		3.234	3.3	3.366	V
	V _{O2}	4.3 V ≤ V _{IN} ≤ 12 V, 0 A ≤ I _O ≤ 1 A	(3.201)	–	(3.399)	V
Line Regulation	REG _{IN}	4.3 V ≤ V _{IN} ≤ 12 V	–	6.0	25.0	mV
Load Regulation	REG _L	0 A ≤ I _O ≤ 1 A	–	4.2	50.0	mV
Quiescent Current	I _{BIAS}	I _O = 0 A	–	1.8	4.0	mA
		I _O = 0.5 A	–	18.0	(30.0)	mA
Startup Quiescent Current	I _{BIAS(S)}	V _{IN} = 3.1 V, I _O = 0 A	–	11.0	30.0	mA
		V _{IN} = 3.7 V, I _O = 1 A	–	–	(80.0)	mA
Quiescent Current Change	ΔI _{BIAS}	4.3 V ≤ V _{IN} ≤ 12 V	–	(3.0)	(15.0)	mA
Output Noise Voltage	V _n	10 Hz ≤ f ≤ 100 kHz	–	82.0	–	μV _{r.m.s.}
Ripple Rejection	R•R	f = 120 Hz, 4.3 V ≤ V _{IN} ≤ 5.3 V, I _O = 0.3 A	–	58	–	dB
Dropout Voltage	V _{DIF}	I _O = 0.5 A	–	0.36	0.6	V
		I _O = 1 A	–	(0.7)	–	V
Short Circuit Current	I _{Oshort}	V _{IN} = 5.0 V	(0.1)	0.6	(0.8)	A
		V _{IN} = 12 V	–	(0.4)	–	A
Peak Output Current	I _{Opeak}	V _{IN} = 5.0 V	1.0	1.5	(1.6)	A
		V _{IN} = 12 V	–	(1.1)	–	A
Temperature Coefficient of Output Voltage	ΔV _O /ΔT	0°C ≤ T _J ≤ 125°C, I _O = 5 mA	–	0.4	–	mV/°C

Remark Values in parentheses are product design values, and are thus provided as reference values.

μPC2905B (T_J = 25°C, V_{IN} = 6.0 V, I_O = 0.5 A, C_{IN} = 0.1 μF, C_{OUT} = 10 μF, unless otherwise specified)

Parameter	Symbol	Conditions	MIN.	TYP.	MAX.	Unit
Output Voltage	V _{O1}		4.90	5.0	5.10	V
	V _{O2}	6.0 V ≤ V _{IN} ≤ 12 V, 0 A ≤ I _O ≤ 1 A	(4.85)	–	(5.15)	V
Line Regulation	REG _{IN}	6.0 V ≤ V _{IN} ≤ 12 V	–	6.5	25.0	mV
Load Regulation	REG _L	0 A ≤ I _O ≤ 1 A	–	5.0	80.0	mV
Quiescent Current	I _{BIAS}	I _O = 0 A	–	1.8	4.0	mA
		I _O = 0.5 A	–	18.0	(30.0)	mA
Startup Quiescent Current	I _{BIAS(S)}	V _{IN} = 4.8 V, I _O = 0 A	–	11.0	30.0	mA
		V _{IN} = 5.5 V, I _O = 1 A	–	–	(80.0)	mA
Quiescent Current Change	ΔI _{BIAS}	6.0 V ≤ V _{IN} ≤ 12 V	–	(3.0)	(15.0)	mA
Output Noise Voltage	V _n	10 Hz ≤ f ≤ 100 kHz	–	122.0	–	μV _{r.m.s.}
Ripple Rejection	R•R	f = 120 Hz, 6.0 V ≤ V _{IN} ≤ 7 V, I _O = 0.3 A	–	57	–	dB
Dropout Voltage	V _{DIF}	I _O = 0.5 A	–	0.38	0.6	V
		I _O = 1 A	–	(0.7)	–	V
Short Circuit Current	I _{Oshort}	V _{IN} = 6.5 V	(0.1)	0.65	(0.8)	A
		V _{IN} = 12 V	–	(0.4)	–	A
Peak Output Current	I _{Opeak}	V _{IN} = 6.5 V	1.0	1.5	(1.6)	A
		V _{IN} = 12 V	–	(1.1)	–	A
Temperature Coefficient of Output Voltage	ΔV _O /ΔT	0°C ≤ T _J ≤ 125°C, I _O = 5 mA	–	0.6	–	mV/°C

Remark Values in parentheses are product design values, and are thus provided as reference values.

TYPICAL CHARACTERISTICS ($T_A = 25^\circ\text{C}$)

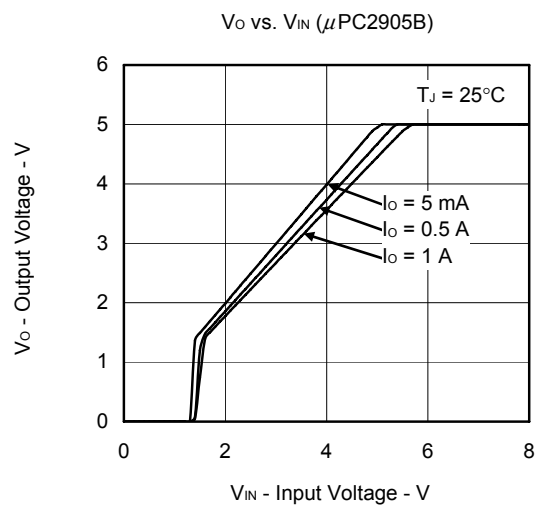
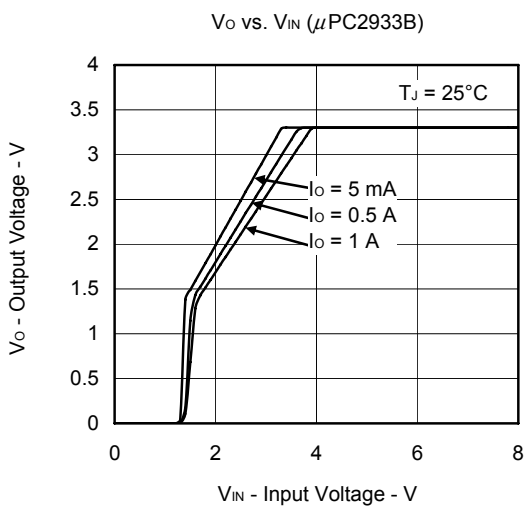
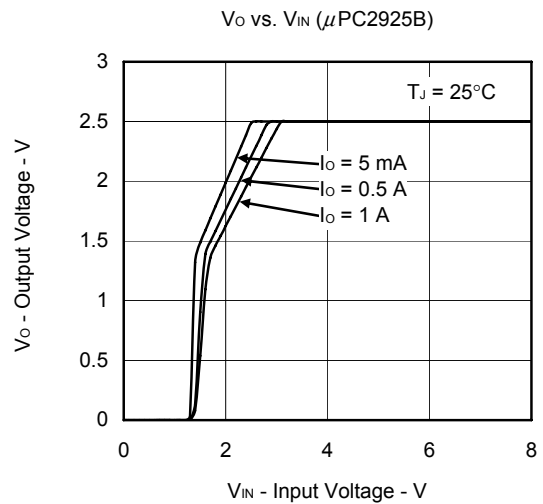
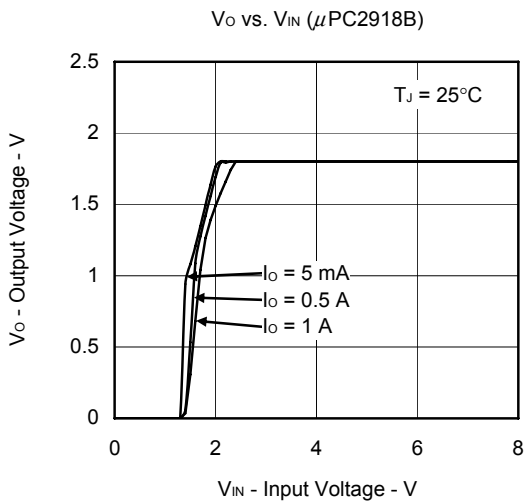
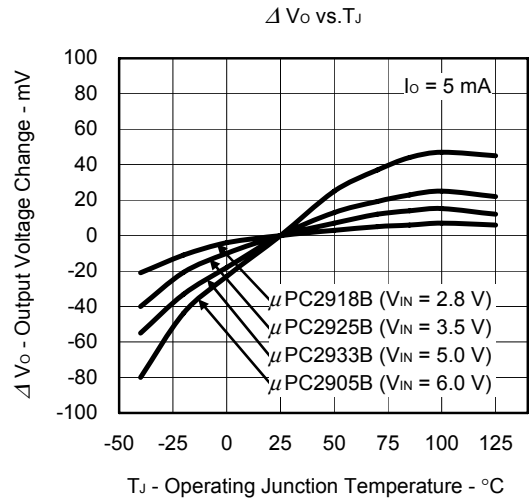
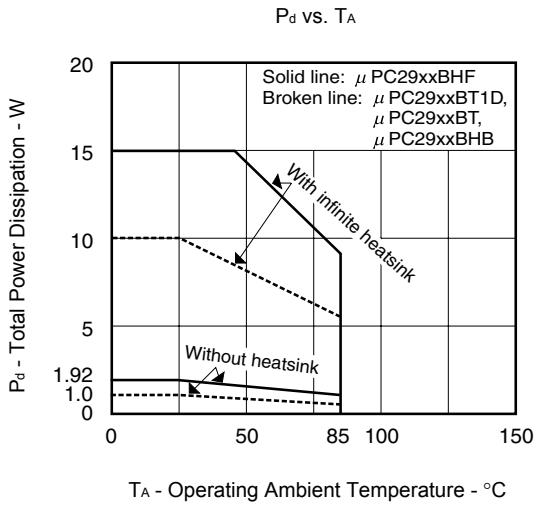

I_{BIAS} ($I_{BIAS(s)}$) vs. V_{IN} (μ PC2918B)

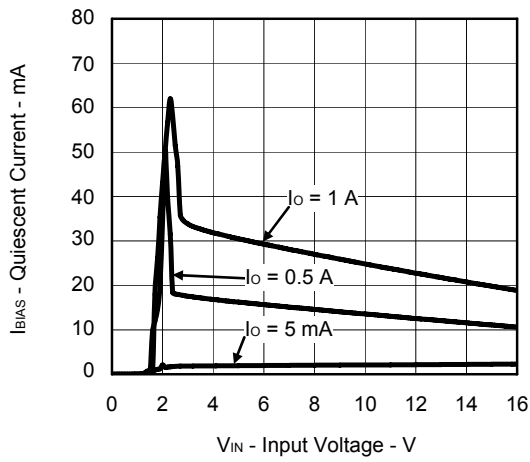

I_{BIAS} ($I_{BIAS(s)}$) vs. V_{IN} (μ PC2925B)

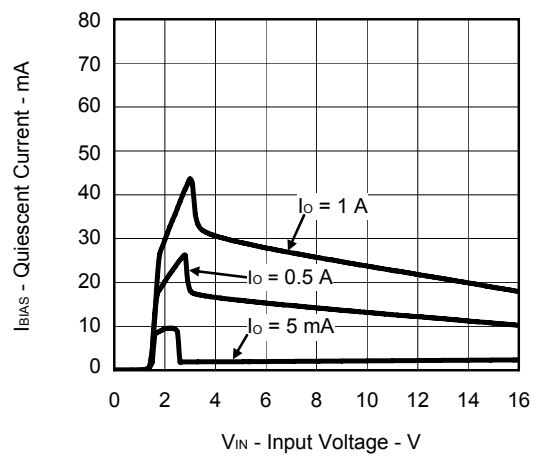

I_{BIAS} ($I_{BIAS(s)}$) vs. V_{IN} (μ PC2933B)

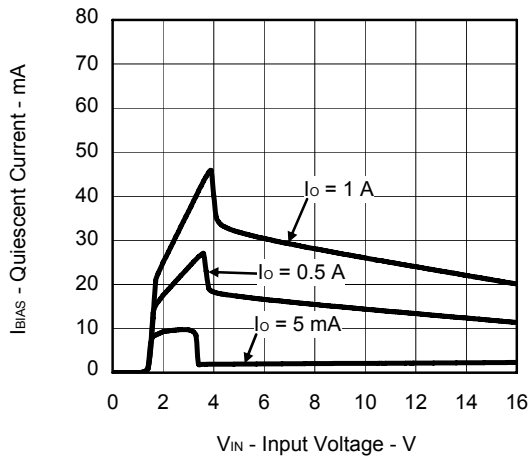

I_{BIAS} ($I_{BIAS(s)}$) vs. V_{IN} (μ PC2905B)

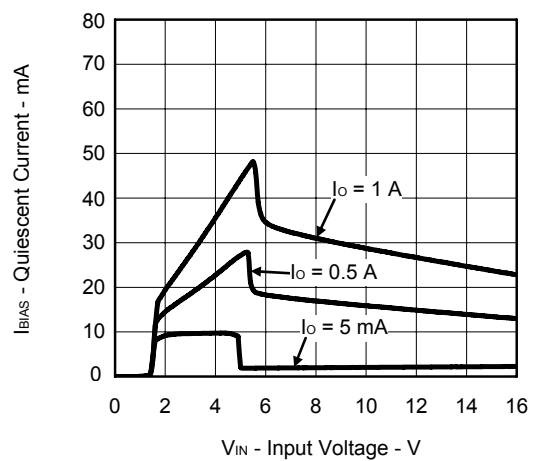

V_{DIF} vs. T_J

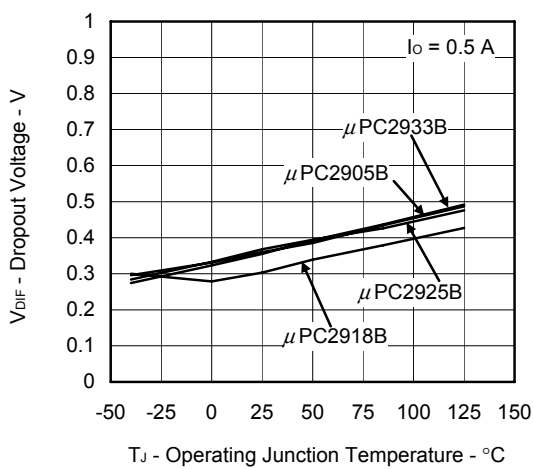

I_{Opeak} vs. V_{DIF}

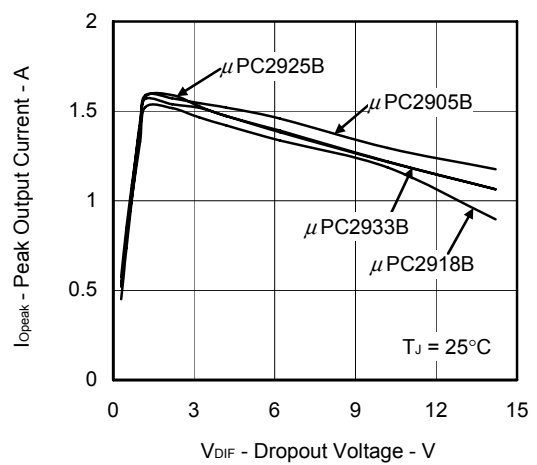

R•R vs. f (μ PC2918B)

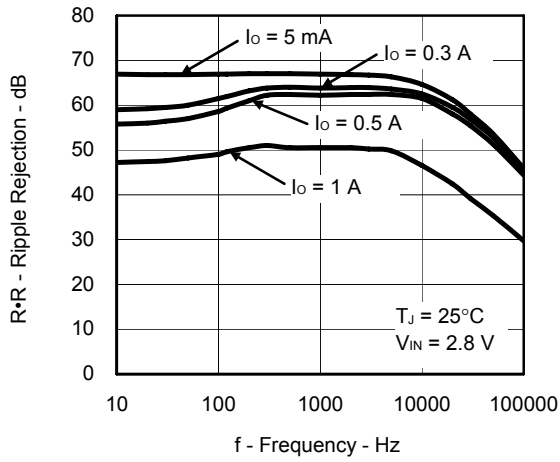

R•R vs. f (μ PC2925B)

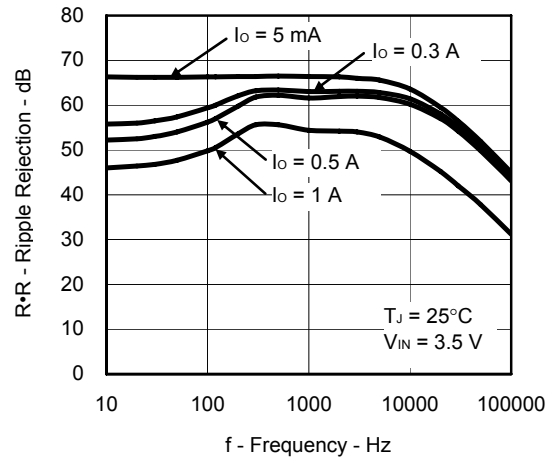

R•R vs. f (μ PC2933B)

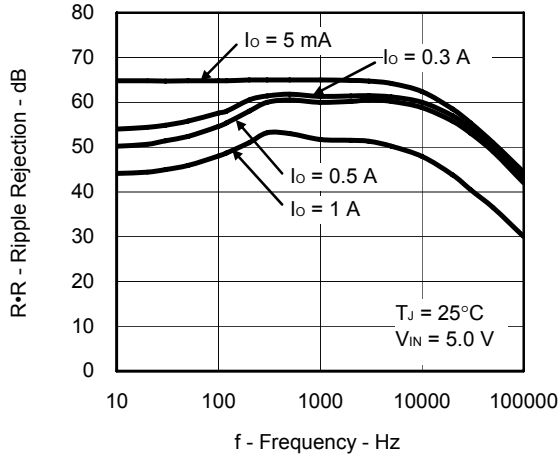

R•R vs. f (μ PC2905B)

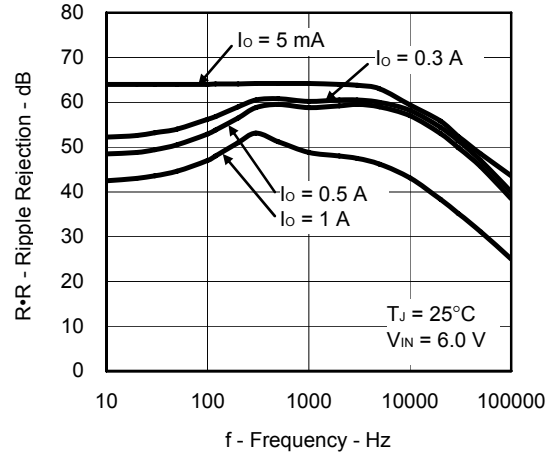

V_{DIF} vs. I_o

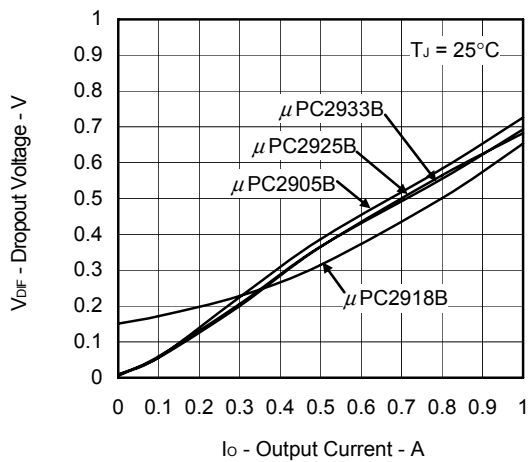

V_o vs. I_o (μ PC2918B)

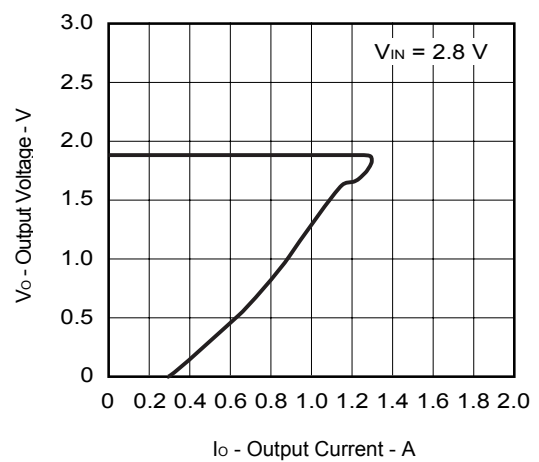

V_o vs. I_o (μ PC2925B)

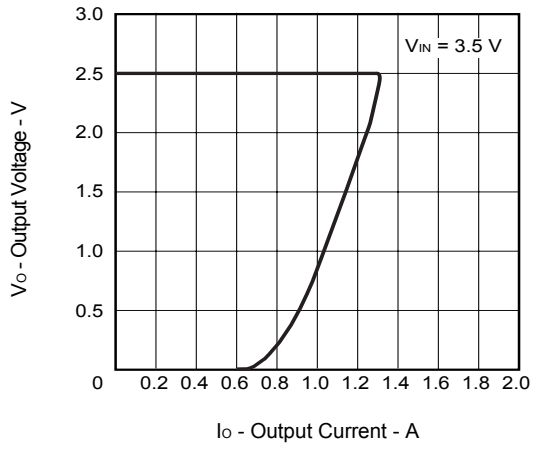

V_o vs. I_o (μ PC2933B)

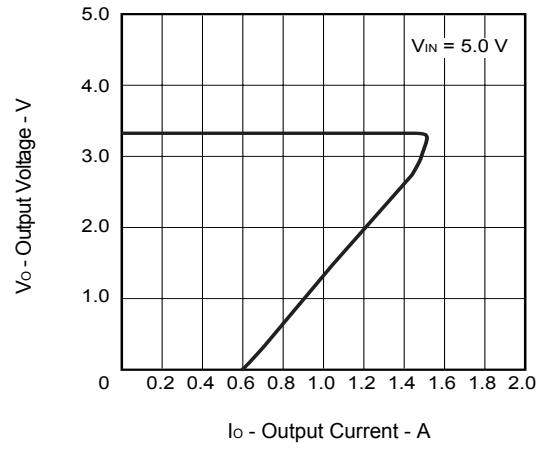

V_o vs. I_o (μ PC2905B)

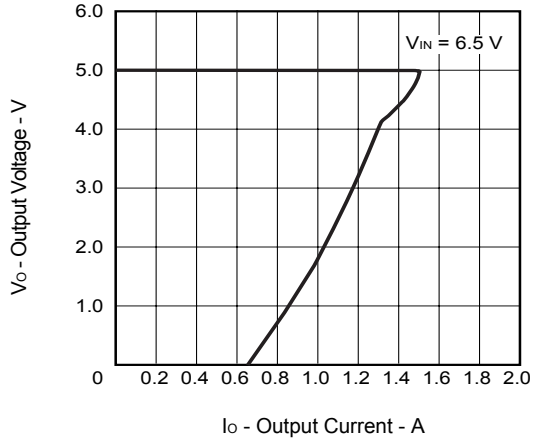

PACKAGE DRAWINGS (Unit: mm)

μPC2918BHF, μPC2925BHF, μPC2933BHF, μPC2905BHF

3PIN PLASTIC SIP (MP-45G)

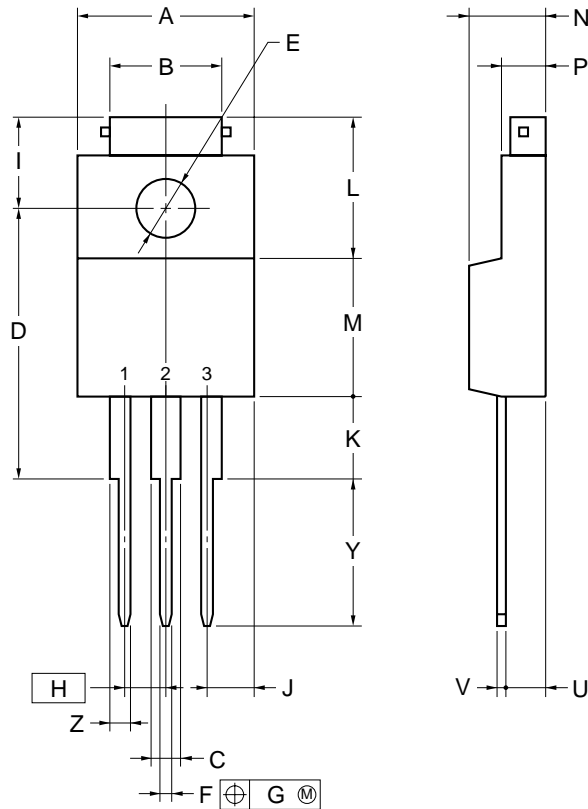

NOTE

Each lead centerline is located within 0.25 mm of its true position (T.P.) at maximum material condition.

ITEM	MILLIMETERS
A	10.0±0.2
B	7.0±0.2
C	1.50±0.2
D	17.0±0.3
E	φ3.3±0.2
F	0.75±0.10
G	0.25
H	2.54 (T.P.)
I	5.0±0.3
J	2.46±0.2
K	5.0±0.2
L	8.5±0.2
M	8.5±0.2
N	4.5±0.2
P	2.8±0.2
U	2.4±0.5
V	0.65±0.10
Y	8.9±0.7
Z	1.30±0.2

P3HF-254B-4

μ PC2918BHB, μ PC2925BHB, μ PC2933BHB, μ PC2905BHB

SC-64 (MP-3)

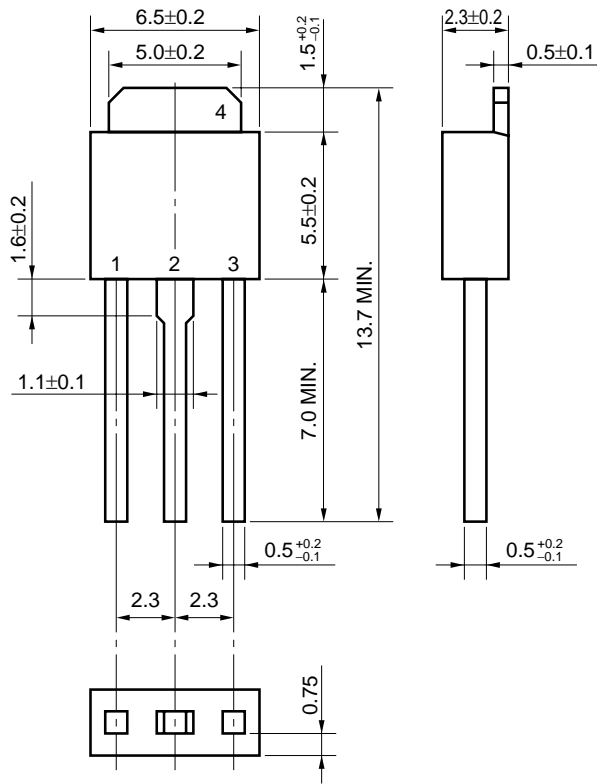

μ PC2918BT, μ PC2925BT, μ PC2933BT, μ PC2905BT

<R> SC-63 (MP-3Z) (Unit: mm)

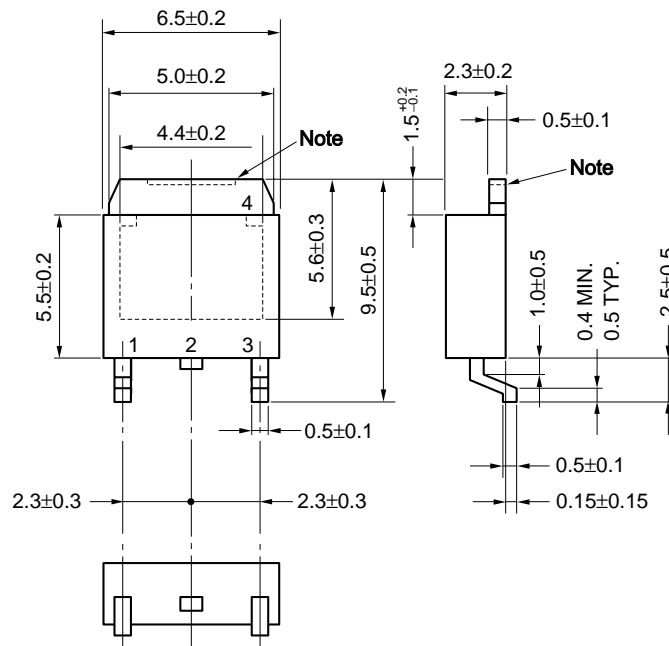

μPC2918BT1D, μPC2925BT1D, μPC2933BT1D, μPC2905BT1D

TO-252 (MP-3ZK)

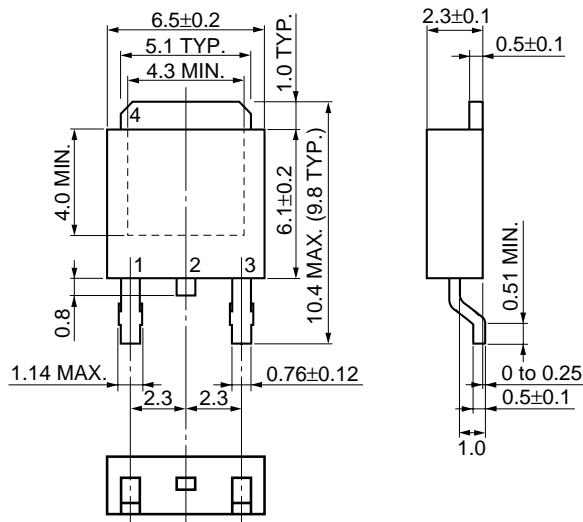

<R> **RECOMMENDED MOUNTING CONDITIONS**

The μPC29xxB Series should be soldered and mounted under the following recommended conditions.

For soldering methods and conditions other than those recommended below, contact an NEC Electronics sales representative.

For technical information, see the following website.

Semiconductor Device Mount Manual (<http://www.necel.com/pkg/en/mount/index.html>)

Surface Mount Device

μPC29xxBT Series: SC-63 (MP-3Z)

μPC29xxBT1D Series: TO-252 (MP-3ZK)

Process	Conditions	Symbol
Infrared Ray Reflow	Peak temperature: 260°C or below (Package surface temperature), Reflow time: 60 seconds or less (at 220°C or higher), Maximum number of reflow processes: 3 times or less.	IR60-00-3
Vapor Phase Soldering	Peak temperature: 215°C or below (Package surface temperature), Reflow time: 40 seconds or less (at 200°C or higher), Maximum number of reflow processes: 3 times or less.	VP15-00-3
Partial Heating Method	Pin temperature: 350°C or below, Heat time: 3 seconds or less (Per each side of the device).	P350

μPC29xxBT-AZ Series^{Note1}, μPC29xxBT-AY Series^{Note2}: SC-63 (MP-3Z)

μPC29xxBT1D-AT Series^{Note3}: TO-252 (MP-3ZK)

Process	Conditions	Symbol
Infrared Ray Reflow	Peak temperature: 260°C or below (package surface temperature), Reflow time: 60 seconds or less (at 220°C or higher), Maximum number of reflows processes: 3 times or less.	IR60-00-3
Partial Heating Method	Pin temperature: 350°C or below, Heat time: 3 seconds or less (per each side of the device).	P350

Notes 1. Pb-free (This product does not contain Pb in the external electrode.)

2. Pb-free (This product does not contain Pb in the external electrode, Sn100% plating.)

3. Pb-free (This product does not contain Pb in the external electrode and other parts.)

Caution Apply only one kind of soldering condition to a device, except for "partial heating method", or the device will be damaged by heat stress.

Remark Flux: Rosin-based flux with low chlorine content (chlorine 0.2 Wt% or below) is recommended.

Type of Through-hole Device

μPC29xxBHF Series, μPC29xxBHF-AZ Series ^{Note1}: Isolated TO-220 (MP-45G)

μPC29xxBHB Series, μPC29xxBHB-AZ Series ^{Note1}, μPC29xxBHB-AY Series ^{Note2}: SC-64 (MP-3)

Process	Conditions	Symbol
Wave Soldering (only to leads)	Solder temperature: 260°C or below, Flow time: 10 seconds or less	WS60-00-1
Partial Heating Method	Pin temperature: 350°C or below, Heat time: 3 seconds or less (per each pin).	P350

Notes 1. Pb-free (This product does not contain Pb in the external electrode.)

2. Pb-free (This product does not contain Pb in the external electrode, Sn100% plating.)

Caution For through-hole device, the wave soldering process must be applied only to leads, and make sure that the package body does not get jet soldered.

REFERENCE DOCUMENTS

	USER'S MANUAL USAGE OF THREE TERMINAL REGULATORS	Document No.G12702E
<R>	REVIEW OF QUALITY AND RELIABILITY HANDBOOK	Document No.C12769E
	INFORMATION VOLTAGE REGULATOR OF SMD	Document No.G11872E
	SEMICONDUCTOR DEVICE MOUNT MANUAL	http://www.necel.com/pkg/en/mount/index.html

- **The information in this document is current as of August, 2007. The information is subject to change without notice. For actual design-in, refer to the latest publications of NEC Electronics data sheets or data books, etc., for the most up-to-date specifications of NEC Electronics products. Not all products and/or types are available in every country. Please check with an NEC Electronics sales representative for availability and additional information.**
- No part of this document may be copied or reproduced in any form or by any means without the prior written consent of NEC Electronics. NEC Electronics assumes no responsibility for any errors that may appear in this document.
- NEC Electronics does not assume any liability for infringement of patents, copyrights or other intellectual property rights of third parties by or arising from the use of NEC Electronics products listed in this document or any other liability arising from the use of such products. No license, express, implied or otherwise, is granted under any patents, copyrights or other intellectual property rights of NEC Electronics or others.
- Descriptions of circuits, software and other related information in this document are provided for illustrative purposes in semiconductor product operation and application examples. The incorporation of these circuits, software and information in the design of a customer's equipment shall be done under the full responsibility of the customer. NEC Electronics assumes no responsibility for any losses incurred by customers or third parties arising from the use of these circuits, software and information.
- While NEC Electronics endeavors to enhance the quality, reliability and safety of NEC Electronics products, customers agree and acknowledge that the possibility of defects thereof cannot be eliminated entirely. To minimize risks of damage to property or injury (including death) to persons arising from defects in NEC Electronics products, customers must incorporate sufficient safety measures in their design, such as redundancy, fire-containment and anti-failure features.
- NEC Electronics products are classified into the following three quality grades: "Standard", "Special" and "Specific".
The "Specific" quality grade applies only to NEC Electronics products developed based on a customer-designated "quality assurance program" for a specific application. The recommended applications of an NEC Electronics product depend on its quality grade, as indicated below. Customers must check the quality grade of each NEC Electronics product before using it in a particular application.
 - "Standard": Computers, office equipment, communications equipment, test and measurement equipment, audio and visual equipment, home electronic appliances, machine tools, personal electronic equipment and industrial robots.
 - "Special": Transportation equipment (automobiles, trains, ships, etc.), traffic control systems, anti-disaster systems, anti-crime systems, safety equipment and medical equipment (not specifically designed for life support).
 - "Specific": Aircraft, aerospace equipment, submersible repeaters, nuclear reactor control systems, life support systems and medical equipment for life support, etc.

The quality grade of NEC Electronics products is "Standard" unless otherwise expressly specified in NEC Electronics data sheets or data books, etc. If customers wish to use NEC Electronics products in applications not intended by NEC Electronics, they must contact an NEC Electronics sales representative in advance to determine NEC Electronics' willingness to support a given application.

(Note)

- (1) "NEC Electronics" as used in this statement means NEC Electronics Corporation and also includes its majority-owned subsidiaries.
- (2) "NEC Electronics products" means any product developed or manufactured by or for NEC Electronics (as defined above).